



METAL STRIPS & RACKS

AGT's Metal Strips & Racks are mobile, reliable, heavy duty, versatile, durable, and lightweight. They are available in many colors and AGT has the best prices in the industry. These products are designed to contribute effectively to maximizing product visibility and increasing retail sales. Among the products are:



- 59** Hanging Metal Clip Racks
- 60** Rotating Clip Racks for Floors & Countertops
- 61** Standing Metal Display Strip Racks
- 62** Metal Merchandise Strips

Hanging Metal Clip Racks

Item	Description	Hanging Clip Racks
31 2010 01	2 strips, 13 clips, 26 total clips	

- Designed especially for displaying related products on shelving units
- Saves valuable shelf space
- Securely holds heavier package weights
- Sign card holder on each strip
- 33" length
- Durable metal construction
- Available in many stock colors
- Custom colors available on request

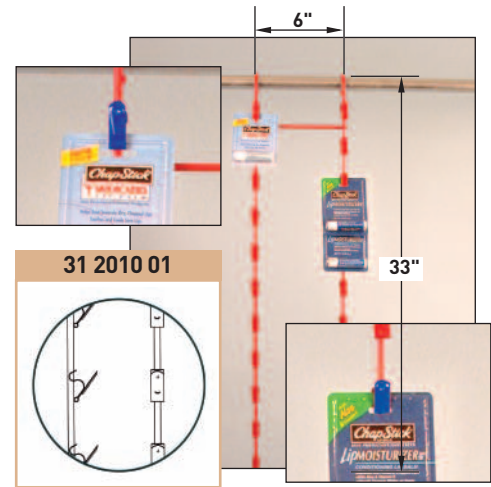

Item	Description	Hanging Clip Racks
31 2011 01	3 strips, 13 clips, 39 total clips	

- Works great with shelving units
- Displays and increases sales of complementary products
- 33" length
- Durable metal construction
- Available in many stock colors
- Custom colors available on request

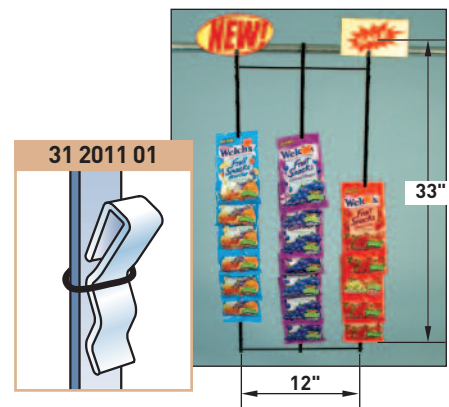

Item	Description	Hanging Clip Racks
31 2012 01	4 strips, 13 clips, 52 total clips	

- Sells related product on non-utilized area with shelving units
- Sign holder on top clip
- 33" length
- Durable metal construction
- Available in many stock colors
- Custom colors available on request

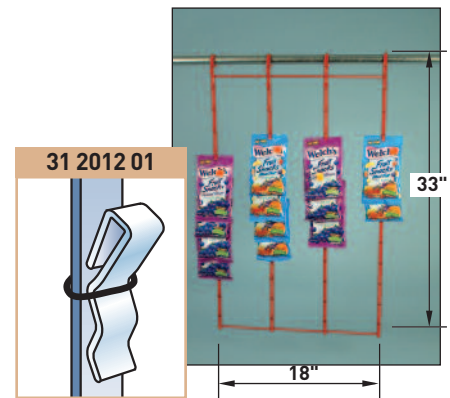

Item	Description	Hanging Clip Racks
31 2013 01	3 strips, 18 clips, 54 total clips	

- Ideal for shelving units
- Proven to increase sales
- Saves valuable shelf space
- 40.625" length
- Durable metal construction
- Available in many stock colors
- Custom colors available on request

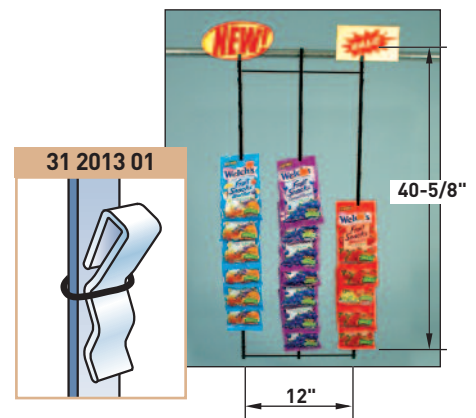

Rotating Clip Racks for Floors & Countertops

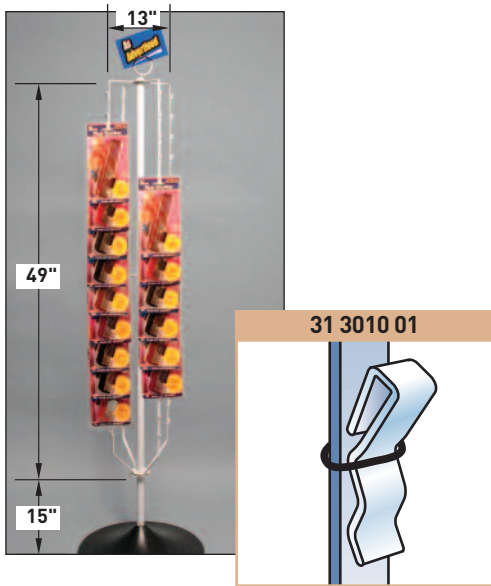

Rotating Clip Rack for Floors

- Sturdy, lightweight, portable rack perfect for end of aisle displays
- Saves shelf space and utilizes non-productive yet highly visible locations
- Rack easily rotates on ball-bearing spinner
- 64" tall
- Durable metal construction with stable plastic base
- Available in a variety of colors
- Custom colors available on request

Item	Size
31 3010 01	4 strips, 18 clips, 72 total clips

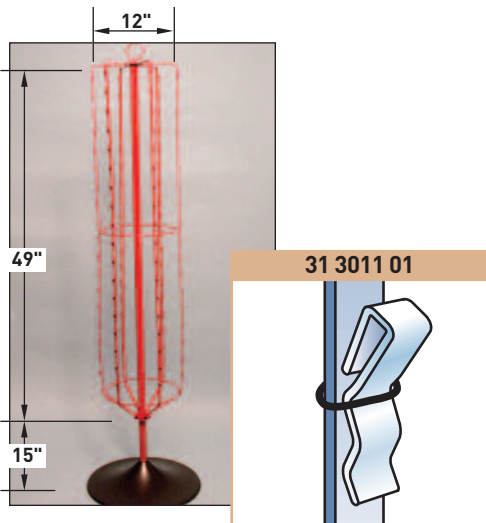

Rotating Clip Rack for Floors

- Sturdy, lightweight, portable rack perfect for end of aisle displays
- Saves shelf space and utilizes non-productive yet highly visible locations
- Rack easily rotates on ball-bearing spinner
- 64" tall
- Durable metal construction with stable plastic base
- Available in a variety of colors
- Custom colors available on request

Item	Size
31 3011 01	6 strips, 18 clips, 108 total clips
31 3011 02	8 strips, 18 clips, 144 total clips

Countertop

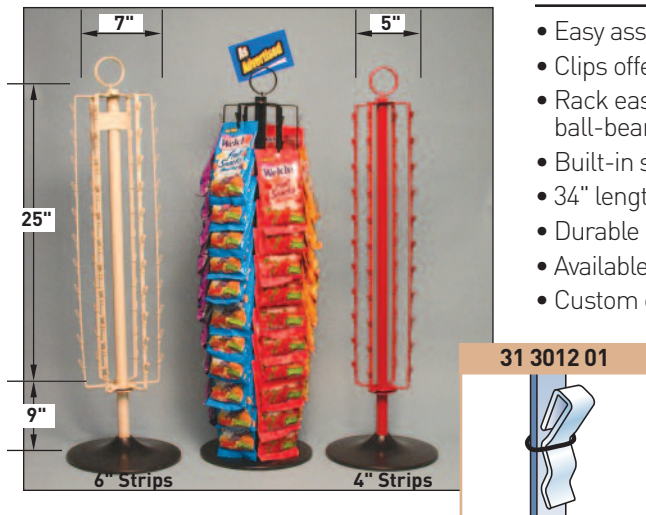

Rotating Clip Rack for Countertop Units

- Easy assembly—requires no tools
- Clips offer optimum package holding
- Rack easily rotates on ball-bearing spinner
- Built-in sign holder
- 34" length
- Durable metal construction with stable plastic base
- Available in a variety of colors
- Custom colors available on request

Item	Size
31 3012 01	4 strips, 11 clips, 44 total clips
31 3012 02	6 strips, 11 clips, 66 total clips

Standing Metal Display Strip Racks

Standing Clip Rack for Countertops

Item	Description
31 4010 01	2 strips, 13 clips, 26 total clips

- Attractive and versatile design works ideally on all countertops
- Increases sales through impulse purchasing
- Metal clips securely hold products in place—easily unloads/ reloads
- Sign card holder on each strip
- Counter stands have clips on both sides
- 22" tall
- Durable metal construction
- Available in many stock colors
- Custom colors available upon request

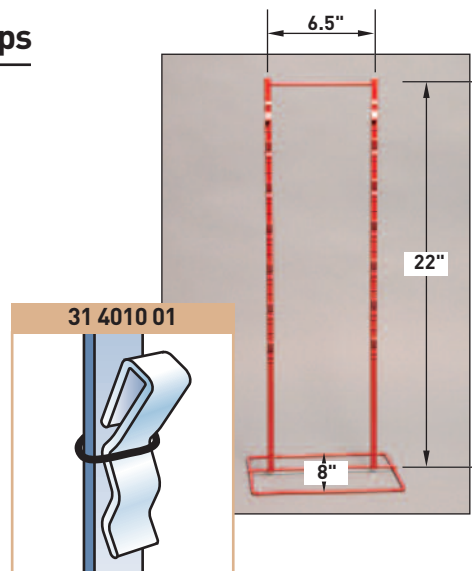

Standing Clip Rack for Countertops

Item	Description
31 4011 01	3 strips, 13 clips, 39 total clips

- Works great on displaying products at check-out counters
- Proven to increase sales of merchandise
- Sign card holder on each strip
- Counter stands have clips on both sides
- 22" tall
- Durable metal construction
- Available in many stock colors
- Custom colors available upon request

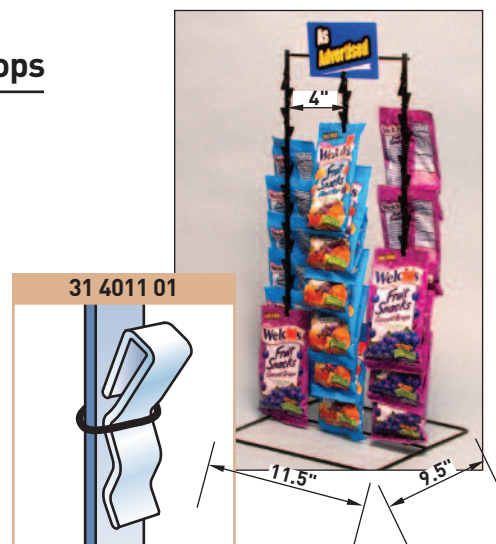

Extra-Wide Standing Clip Rack for Countertops

Item	Description
31 4012 01	3 strips, 13 clips, 39 total clips

- Showcases related product on under-utilized areas such as deli and check-out counters
- Extra-wide spacing between clips to accommodate larger products
- Counter stands have clips on both sides
- 25" tall
- Durable metal construction
- Available in many stock colors
- Custom colors available upon request

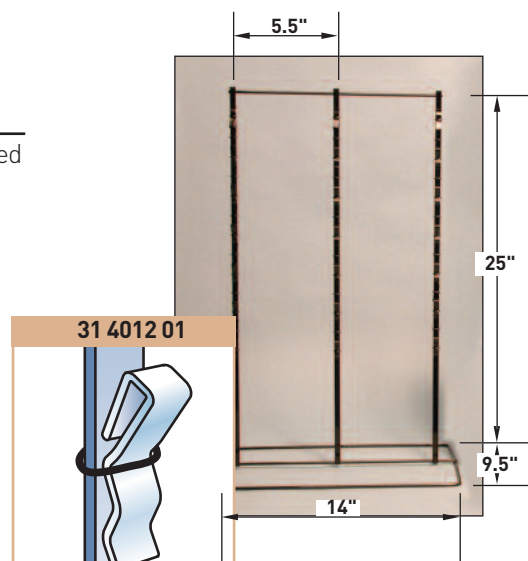

Metal Merchandise Strips

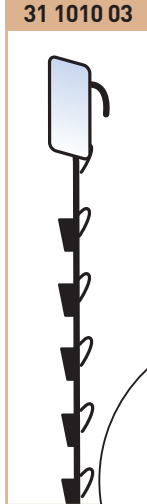
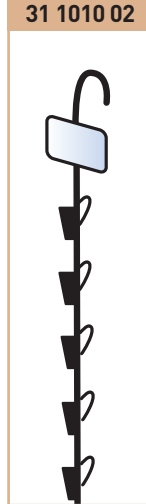

Metal Strips

- 31" long with 12-hooks.
- Available with or without label holder.
- Different colors available on request

Item	Size	Hooks
31 1010 01	31" L	12
31 1010 02	31" L	12
31 1010 03	31" L	12

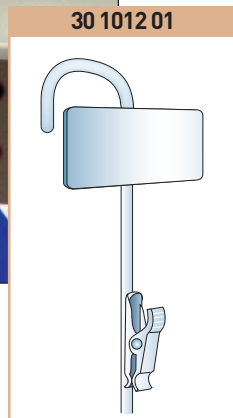
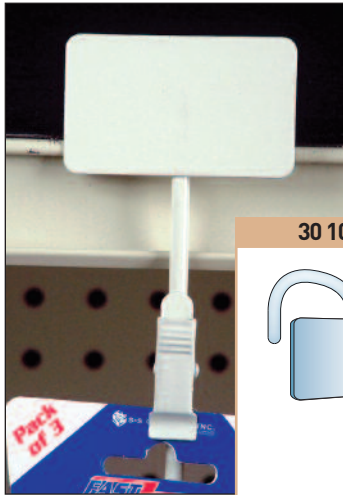
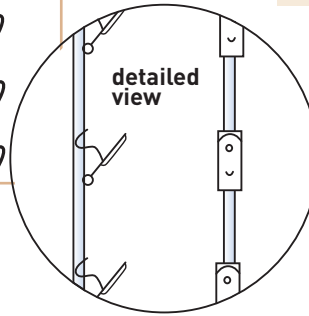

Metal Merchandise Strip

- 31" long with 12 stations or 16-5/8" with 6 stations
- Available with or without label holder
- With sign channel 1-1/4" H x 3-1/2" W
- Different colors available on request

Item	Size	Stations
31 1011 01	31" L	12
31 1011 02	16-5/8" L	6

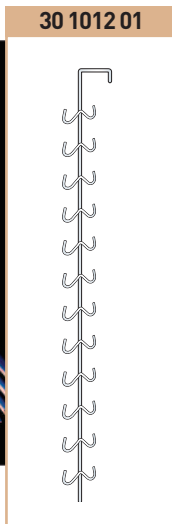

Two-Sided Metal Display Strip

- Super strong metal construction holds heavier products securely!
- Easy to load open-hooks on both sides
- Doubles your sales capacity for bigger profits!
- Available with 24 stations
- Each station holds 5-10 packages depending on size of package

Item	Size
31 1012 01	36" L